

PROPRIETARY
 EXCEPT AS OTHERWISE AGREED IN WRITING, THE INFORMATION AND DESIGN DISCLOSED HEREIN IS THE PROPERTY OF TAPESWITCH CORPORATION, AND MUST NOT BE COPIED OR DISTRIBUTED OUTSIDE TAPESWITCH, EXCEPT TO AUTHORIZED PERSONS WITH A GENUINE NEED-TO-KNOW WHO BY THE USE HEREOF ACKNOWLEDGE TAPESWITCH OWNERSHIP AND AGREE TO MAINTAIN THIS INFORMATION IN STRICT CONFIDENCE.

REV.NO.	DESCRIPTIONS	DATE	APPRO.
.	.	.	.

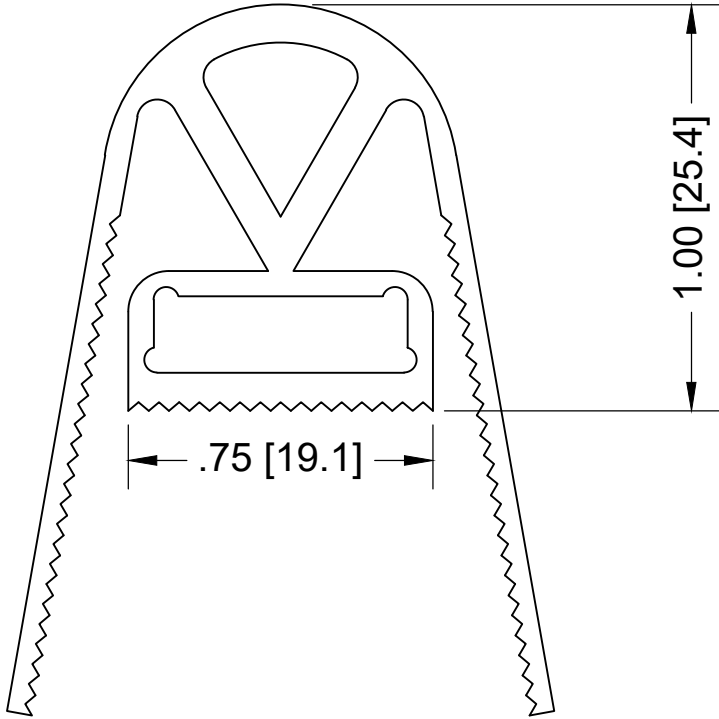

SHEET 1 OF 1

TS-109 HOUSING DIMENSIONS	SCALE N/A	DRAWN J.G.
	APPD. .	DATE 7/5/18
TAPESWITCH CORPORATION FARMINGDALE, NEW YORK, U.S.A.	SIZE A	DRAWING NUMBER .

PART #: MAT'L: n/a