

DISCLAIMER
 WHILE EVERY EFFORT HAS BEEN MADE TO ENSURE THE ACCURACY
 OF THE INFORMATION PROVIDED, NO LIABILITY CAN BE TAKEN FOR
 ANY ERRORS OR OMISSION. TAPESWITCH CORPORATION RESERVES
 THE RIGHT TO ALTER SPECIFICATIONS AND INTRODUCE IMPROVEMENTS
 WITHOUT PRIOR NOTICE.

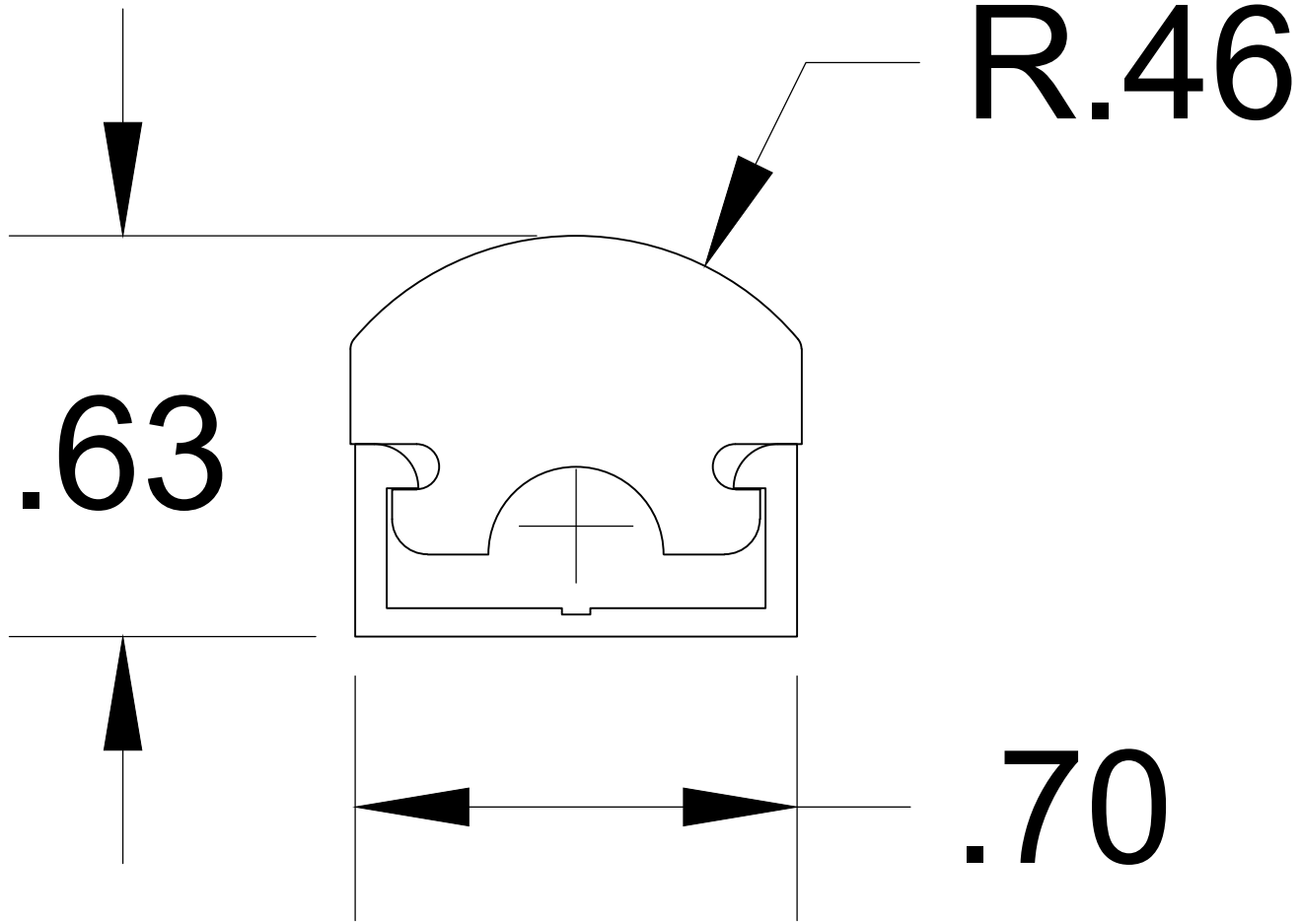

TS-6 FLAT PROFILE DIMENSIONS	SCALE	N/A	DRAWN	DS
	APPD.	.	DATE	9/5/18
TAPESWITCH CORPORATION FARMINGDALE, NEW YORK, U.S.A.	SIZE	DRAWING NUMBER		
	A	.		