

DISCLAIMER  
 WHILE EVERY EFFORT HAS BEEN MADE TO ENSURE THE ACCURACY OF THE INFORMATION PROVIDED, NO LIABILITY CAN BE TAKEN FOR ANY ERRORS OR OMISSION. TAPESWITCH CORPORATION RESERVES THE RIGHT TO ALTER SPECIFICATIONS AND INTRODUCE IMPROVEMENTS WITHOUT PRIOR NOTICE.

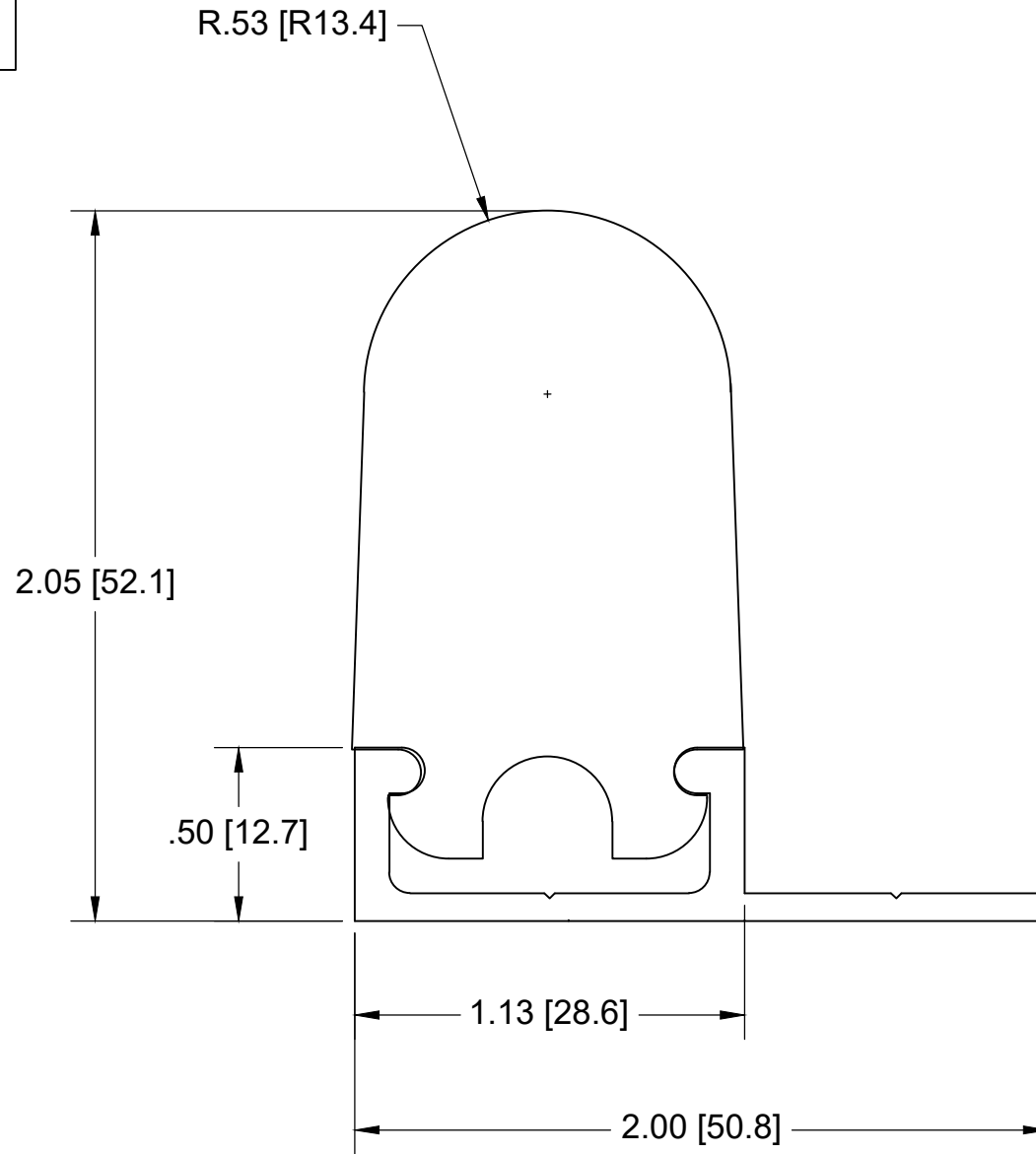

TS-47 FLANGE PROFILE DIMENSIONS	SCALE	N/A	DRAWN	DS
	APPD.	.	DATE	9/5/18
TAPESWITCH CORPORATION FARMINGDALE, NEW YORK, U.S.A.	SIZE	DRAWING NUMBER		
	A	.		