

DISCLAIMER
 WHILE EVERY EFFORT HAS BEEN MADE TO ENSURE THE ACCURACY OF THE INFORMATION PROVIDED, NO LIABILITY CAN BE TAKEN FOR ANY ERRORS OR OMISSION. TAPESWITCH CORPORATION RESERVES THE RIGHT TO ALTER SPECIFICATIONS AND INTRODUCE IMPROVEMENTS WITHOUT PRIOR NOTICE.

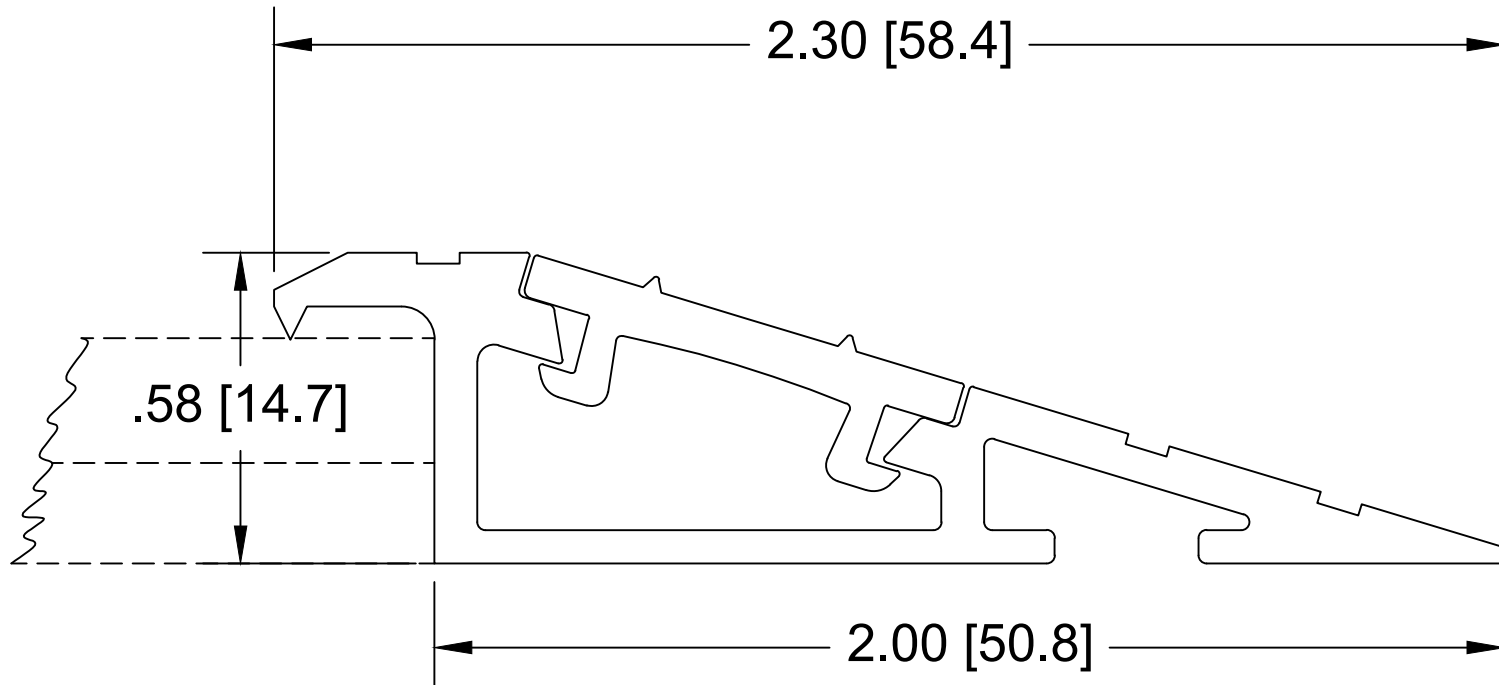

AE3 TRIM PROFILE	SCALE	NTS	DRAWN	D.S.
	APPD.	.	DATE	5/8/17
TAPESWITCH CORPORATION FARMINGDALE, NEW YORK, U.S.A.	SIZE	DRAWING NUMBER		
	A	.		