

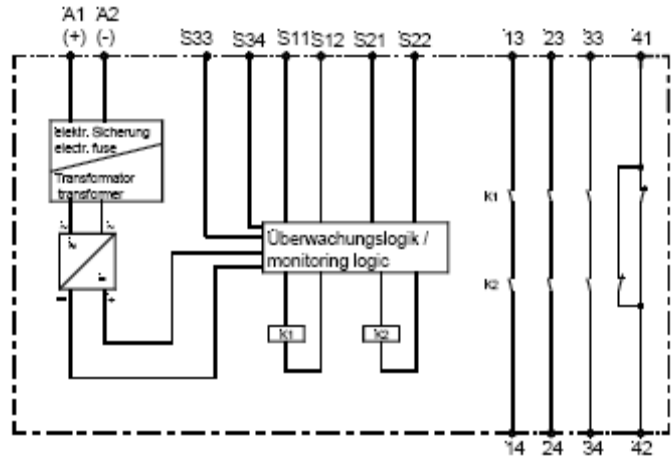

Information Sheet - PRSU/4 Safety Interface Controller

for safety switches, mats, sensing edges, and bumpers



For automatic or external start, see manual.
Supply voltage: 24 Vac/Vdc at 5 VA

4-lead cable connections for CKP Safety Mats:
S11 = black S12 = yellow
S21 = red S22 = white

Switch, mat or edge wiring for safety category 3

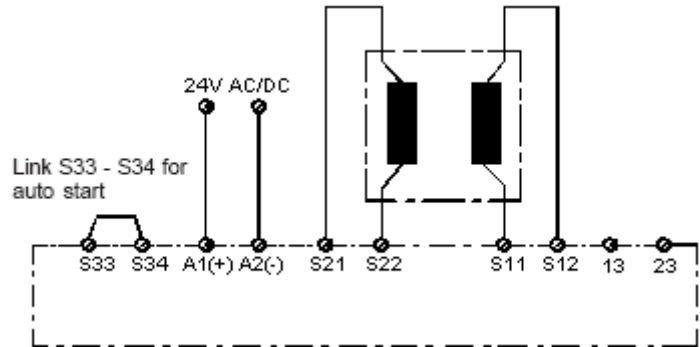

Switch, mat or edge wiring for safety category 1

